

THE DISKCOVER™ SYSTEM

Additional support and how-to videos:
DiskCover.com/Support



AseptiScope.com

San Diego, CA 92103 USA
Customer Support: 1-844-980-2998
support@AseptiScope.com

© 2020 AseptiScope, Inc. All rights reserved. DiskCover, Clean Cassette and AseptiScope and related logos are trademarks of AseptiScope, Inc. 1053-00

THE DISKCOVER™ SYSTEM

from  AseptiScope™

You have made a great choice to
PROTECT YOUR PATIENT

Full instructions for use:
DiskCover.com/DiskCover



DiskCover Dispenser: [\[REF\]](#) DSA-1
DiskCover Clean Cassette™: [\[REF\]](#) CSA-1
Wall Mount: [\[REF\]](#) WMS-01
Informational Placard: [\[REF\]](#) DSA-L1
Each component sold separately

Dispenser, Battery, Clean Cassette, and Placard Installation

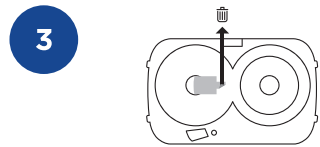
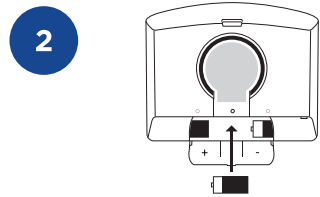
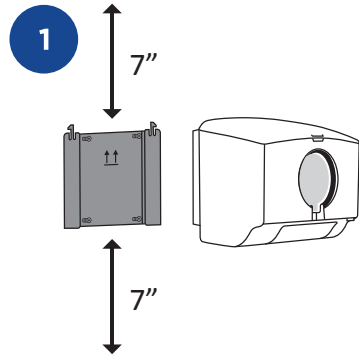

Inspect Clean Cassette for damage, remove shipping insert

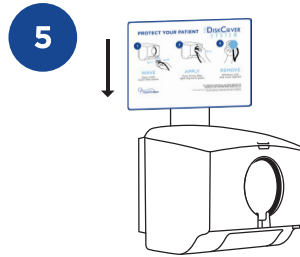
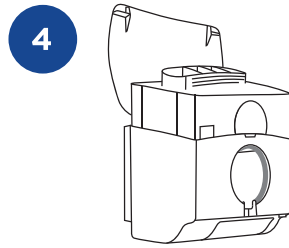

Installation video:
[Vimeo.com/444342458](https://vimeo.com/444342458)



DiskCover System Use

WAVE

Wave under touch-free sensor

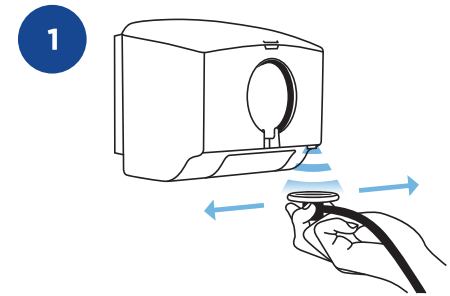

APPLY

Press firmly after light ring turns green

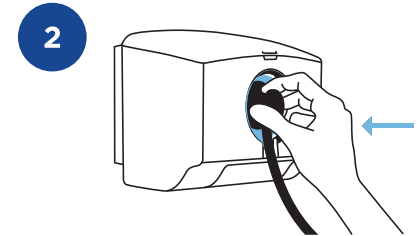

REMOVE

Withdraw with disk cover applied

